

A B C D E F G H

1

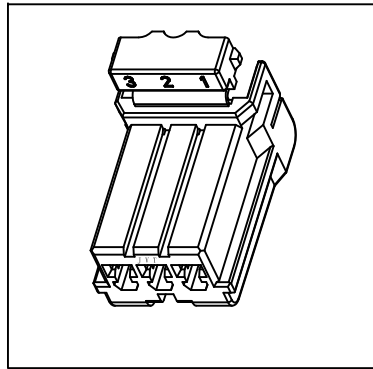
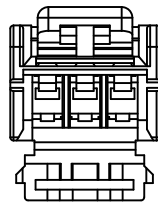
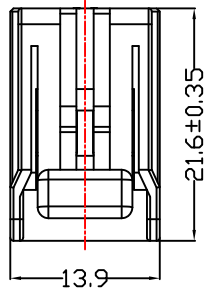
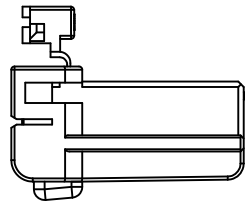
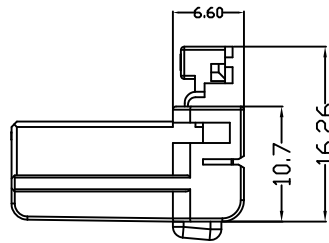
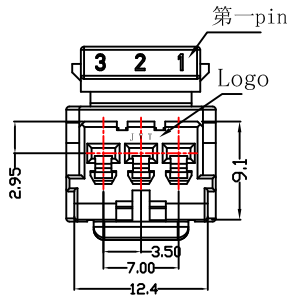
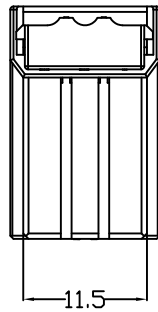

- SPECIFICATION
- Voltage rating: 300V AC, DC
 - Current Rating: 10A, AC, DC
 - Withstand voltage: 500V AC/minute
 - Contact resistance: 20mΩ Max.
 - Insulation resistance: 1000MΩ MIN.
 - Temperature range: -30°C ~ +105°C

- HOUSING
- Material: PBT UL 94V-HB
 - Color: White
 - Mates With Part(s): JVT3505 Terminal

JVT3505HPT-03WH

logo ————

系列码 ————

胶壳 ————

PT-PBT UL94-HB ————

WH-本色

PIN数

- 备注:
1. HSG所有物料均符合ROHS要求
 2. HSG所有尺寸符合图纸要求, 带*为重要尺寸.
 3. HSG外观良好, 不可有杂色, 缺胶, 毛边, 严重缩水等现象.
 4. HSG与JVT3505TP端子保持力≥5.0KG, 及测试针座的匹配度.
 5. HSG印字LOGO要求正确.

GENERAL TOLERANCE	
0	±0.40
.0	±0.30
.00	±0.20
.000	±0.10

4

版本	变更内容	日期	单位	mm	比例	1:1	日期	20170105
----	------	----	----	----	----	-----	----	----------



核准	审核	绘图	品名	AMP-174921 3.5mm 03P HOUSING		
	TONY	YIN	料号	JVT3505HPT-03WH		
			图名	031	版本	A

A B C D E F G H